



 <b>深圳市汇科源电子科技有限公司</b> Shenzhenshi Huikeyuan Electronic Tech.co., LTD		<b>REVISION</b> (版本)	A0
		<b>DATE</b> (日期)	2023.06.08
<b>PART NUMBER</b> (产品编号)	<b>CAR CHARGER</b> <b>C140-140W USB C</b>	<b>CUSTOMER NAME AND MODEL</b> (客户名称和型号)	

Rev. List/版本目录			
Rev. /版本	Date/日期	Description/描述	Design/制订
A0	2023.06.08	New Rev. /新版本	

## Content/目录

1.	Scope (适用范围)	4
2.	Quote Criterion (引用标准)	4
3.	Input Characteristics (输入特性)	4
3.1.	Rated Input Voltage (额定输入电压)	4
3.2.	Rated Input Current (输入电流)	4
4.	Output Characteristics (输出特性)	4
4.1.	Rated Output Voltage (输出额定电压电流)	4
4.2.	Rated Power (额定功率)	5
4.3.	Output Ripple and Noise (输出纹波、噪音)	5
4.4.	Protection (保护)	5
4.4.1.	Over Current Protection (过流保护)	5
4.4.2.	Short Circuit Protection (短路保护)	5
4.4.3.	Thermal protection (过温保护)	5
4.5.	Temperature Rise (温升)	6
5.	Environmental Requirement (环境要求)	6
5.1.	Operating Temperature (工作温度)	6
5.2.	Storage Temperature (储藏温度 8H)	6
5.3.	Operating Humidity (工作湿度)	6
5.4.	Storage Humidity (储藏湿度)	6
6.	Mechanical Requirement (机械要求)	6
6.1.	Drop Test (跌落试验)	6
6.2.	Salty Fog Test for Metal Part (五金件盐雾实验)	6
6.3.	Plug and pull experiment (插拔实验)	7
7.	Mechanical Characteristics (机械性能)	7
7.1.	Appearance (外观)	7
7.2.	Case/Resin Materials (外壳材质)	7
8.	Environmental Performances (环境性能)	7
8.1.	Operating at the Lower temperature (低温工作实验)	7

 <b>深圳市汇科源电子科技有限公司</b> Shenzhenshi Huikeyuan Electronic Tech.co., LTD		<b>REVISION</b> (版本)	A0
		<b>DATE</b> (日期)	2023.06.08
<b>PART NUMBER</b> (产品编号)	<b>CAR CHARGER</b> <b>C140-140W USB C</b>	<b>CUSTOMER NAME AND MODEL</b> (客户名称和型号)	

<b>8.2. Operating at the High Temperature</b> (高温工作实验) .....	7
<b>8.3. Storage at the Lower Temperature</b> ( 低温放置).....	7
<b>8.4. Storage at the Higher Temperature</b> (高温放置) .....	8
<b>8.5. Storage at High Temperature and High Humidity</b> (高温高湿度放置).....	8
<b>8.6. Storage at low Temperature and Low Humidity</b> (低温低湿度放置).....	8
<b>9. Photograph of the Product</b> (产品外观图) .....	8

 <b>深圳市汇科源电子科技有限公司</b> Shenzhenshi Huikeyuan Electronic Tech.co., LTD		<b>REVISION</b> (版本)	A0
		<b>DATE</b> (日期)	2023.06.08
<b>PART NUMBER</b> (产品编号)	<b>CAR CHARGER</b> C140-140W USB C	<b>CUSTOMER NAME AND MODEL</b> (客户名称和型号)	

## 1. Scope (适用范围)

The specification shall be applied to the field of car charger  
 本规格适用于车载充电器领域。

## 2. Quote Criterion (引用标准)

### 2.1 EMI STANDARD EMI 标准

EN 50498: 2010, BS EN 50498: 2010, FCC Part 15 Subpart B ANSI C63.4:2014, J55032(H29)

## 3 Input Characteristics (输入特性)

### 3.1 Rated Input Voltage (额定输入电压)

It is normal for 12Vdc to 24Vdc input DC voltage.  
 ( 额定输入直流 12V~24V)

### 3.2 Rated Input Current (额定输入电流)

It is normal for 15A Max input Current  
 ( 额定输入直流 15A 最大)

## 4 Output Characteristics (输出特性)

### 4.1 Rated Output Voltage Current (输出额定电压电流)

Model 型号	4.1 Output Voltage 输出电 压	4.1 Min Load 最小负载	4.1 Output Current 输出电流	4.1 Load Regulation 负载调整	4.1 Line Regulation 线性调整	4.1 Output Voltage Range 输出电压范围	4.2 Rated Power 额定功率	4.3 Ripple/Noise (p-p) 纹波噪声	4.4.1 Over Current Protection 过流保护
C140-140W USB C	5V	0A	3A	±5%	±1%	4.75V-5.25V	15W	100mV Max	4A Max
	9V	0A	3A	±5%	±1%	8.55V-9.45V	27W	100mV Max	4A Max
	12V	0A	3A	±5%	±1%	11.4V-12.6V	36W	100mV Max	4A Max
	15V	0A	3A	±5%	±1%	14.25V-15.75V	45W	100mV Max	4A Max
	20V	0A	5A	±5%	±1%	19.0V-21.0V	100W	100mV Max	6.5A Max
	28V	0A	5A	±5%	±1%	26.6V-29.4V	140W	100mV Max	6.5A Max

 <b>深圳市汇科源电子科技有限公司</b> Shenzhenshi Huikeyuan Electronic Tech.co., LTD		<b>REVISION</b> (版本)	A0
		<b>DATE</b> (日期)	2023.06.08
<b>PART NUMBER</b> (产品编号)	<b>CAR CHARGER</b> <b>C140-140W USB C</b>	<b>CUSTOMER NAME AND MODEL</b> (客户名称和型号)	

#### 4.2 Rated Power (额定功率)

The rated power is 100Watts.continuously at all specified conditions. Note: the test shall be made under the following conditions, unless otherwise specified: Ambient Temperature 25°C, Relative Humidity 35~85%RH Air Pressure 86~106kPa

(输出功率 100W, 在无特别指定条件下,测试温度为 25°C、湿度为 35~85%RH、气压为 86~106kPa)

#### 4.3 Output Ripple and Noise (输出纹波、噪音)

DC Input 12V. 24V Output ripple voltage is less Measured methods:Performed by 20MHz bandwidth in oscilloscope. Applied 0.1uF ceramic capacitor and 10uF electrolytic capacitor across output connector terminals Measured at the end of DC cable.

(DC 输入 12V 24V 输出端并 0.1uF 与 10uF 电容, 限制示波器带宽 20MHz 时)

#### 4.4 Protection (保护)

##### 4.4.1 Over Current Protection (过流保护)

Over current protection current output (5V/3A) (9V/3A) (12V/3A) (15V/3A) 4A Max  
(20V/5A) (28V/5A) 6.5A Max

After the over current is eliminated, it needs to be restarted (unplugged and reinserted) to resume normal operation.

过流保护电流输出 (5V/3A) (9V/3A) (12V/3A) (15V/3A) 4A 最大

(20V/5A) (28V/5A) 6.5A 最大

过流消除后. 需要重新启动 (拔出后重新插入) 才能恢复正常工作

##### 4.4.2 Short Circuit Protection (短路保护)

When the output short circuit occurs, the input power of the product decreases without damage. When the short circuit is eliminated, it needs to be restarted (re-inserted after pulling out) to resume normal work.

当输出短路时, 产品的输入功率下降而不损坏。当短路消除后, 需要重新启动 (拔出后重新插入) 以恢复正常工作。

##### 4.4.3 Thermal protection (过温保护)

Output over load,the main components of temperature more than 125°C protection (shell temperature was 95°C) Circuit protection,the main components of the temperature dropped to 50°C below normal output

输出过载时,主要元件温度超过 125°C 保护(外壳温度 ≥95°C) 电路保护,主要元件温度降到 50°C 以下恢复正常工作

 <b>深圳市汇科源电子科技有限公司</b> Shenzhenshi Huikeyuan Electronic Tech.co., LTD		<b>REVISION</b> (版本)	A0
		<b>DATE</b> (日期)	2023.06.08
<b>PART NUMBER</b> (产品编号)	<b>CAR CHARGER</b> C140-140W USB C	<b>CUSTOMER NAME AND MODEL</b> (客户名称和型号)	

#### 4.5 Temperature Rise (温升)

The input voltage of 12-24 Vdc is applied at 25°C, and the shell temperature is less than 77°C at the maximum output load.

(在常温 25°C 下输入端施加 12-24Vdc 电压，输出最大负荷状态下，机壳温度小于 77°C。)

### 5 Environmental Requirement (环境要求)

#### 5.1 Operating Temperature (工作温度)

-10°C TO 40°C Full load, Normal operation. 满载, 正常工作.

#### 5.2 Storage Temperature (储藏温度 8H)

-25°C TO +70°C With package/带外壳

#### 5.3 Operating Humidity (工作湿度)

5%(0°C)~90%(40°C),RH,72Hrs,Full load, Normal operating.

5%(0°C)~90%(40°C), 湿度 72 小时, 满载, 正常工作

#### 5.4 Storage Humidity (储藏湿度)

5% ~ 95% RH. Non-condensing

### 6 Mechanical Requirement (机械要求)

#### 6.1 Drop Test (跌落试验)

from 100cm height to the most likely to cause adverse results to the horizontal position of the surface drop test bed three times, the adapter in addition to surface scratches, it should be no dysfunction can cause the adapter and other potentially the harm. (Horizontal surface of the test rig shall be composed of at least 13mm thick hardwood installed in two layers of plywood, each layer of plywood thickness 19-20mm, and then placed on a cement base or equivalent on the ground inelastic)

(从 100cm 高处、以可能对其造成最不利结果的位置跌落至水平表面试验台 3 次, 适配器除表面有擦伤外, 应该没有任何功能障碍和其他方面能导致适配器产生潜在的危害。(水平表面试验台应是由至少 13mm 厚的硬木安装在两层胶合板上组成, 每一层胶合板的厚度为 19-20mm, 然后放在一水泥基座上或等效的无弹性的地面上)

#### 6.2 Salty Fog Test for Metal Part (五金件盐雾实验)

Experiment condition, Salty water thickness: 5%, Equipment Temperature: 35 ~ 40 °C ,put the adapter(unpacking)in the test equipment for 24h, after 24h recovery at 25°C checking the appearance, the metal parts have no erode and rust.

(盐雾试验要求: 调制(工业盐)盐水的浓度为 5%, 设备温度设置为 35~40°C, 适配器不包装, 放入盐

 <b>深圳市汇科源电子科技有限公司</b> Shenzhenshi Huikeyuan Electronic Tech.co., LTD		<b>REVISION</b> (版本)	A0
		<b>DATE</b> (日期)	2023.06.08
<b>PART NUMBER</b> (产品编号)	<b>CAR CHARGER</b> C140-140W USB C	<b>CUSTOMER NAME AND MODEL</b> (客户名称和型号)	

雾试验设备中持续喷雾 24 小时，试验结束后取出，在常温下搁置 24 小时，再检查适配器外观；要求外露金属及电镀件不生锈。)

### 6.3 Plug and pull experiment (插拔实验)

Plug and connector after normal plug 10 times, plug each insert strength is not more than 30N, pull out in 10N to 50N after between continuous pull plug 3000 times Appearance is allowed to have mild damage, but conducting performance is good

(插头与连接器经正常插拔 10 次, 插头每次插入力度不大于 30N, 拔出在 10N-50N 之间后持续插拔 3000 次. 外观允许有轻度损伤, 但对通性能良好)

## 7 Mechanical Characteristics (机械性能)

### 7.1 Appearance (外观)

Visual inspection the case have no visual abnormality, no obvious nick, burr and other mechanical damage, outer metal have no rust. Use limit sample to check for any failures.

(目视检查, 无外观异常, 表面无明显划痕、毛刺及其它机械损伤, 外露金属部分无锈, 其他限度根据样品确认。)

### 7.2 Case/Resin Materials (外壳材质)

Flame resistance applies to UL94-V1

(耐燃性遵循 UL94-V1)

## 8 Environmental Performances (环境性能)

### 8.1 Operating at the Lower temperature (低温工作实验)

At  $-10\pm 2^{\circ}\text{C}$ , with the rated voltage 12-24Vdc charged to the primary and unloaded and full load on the secondary, no abnormality in electric and mechanical characteristic, after 2 hours recovery at the room temperature.

(环境温度  $-10\pm 2^{\circ}\text{C}$ , 在输入端施加额定电压 12-24Vdc 输出端无负荷与满载状态下, 试验 2 小时, 无特性异常)

### 8.2 Operating at the High Temperature (高温工作实验)

At  $40\pm 2^{\circ}\text{C}$ , with the rated voltage 12-24Vdc charged to the primary and unloaded and full load on the secondary. No abnormality in electric and mechanical characteristic after 2 hours recovery at the room temperature.

(环境温度  $40\pm 2^{\circ}\text{C}$ , 在输入端施加额定电压 12-24Vdc 输出端无负荷与满载状态下, 试验 2 小时, 无特性异常)

### 8.3 Storage at the Lower Temperature (低温放置)

At  $-25\pm 2^{\circ}\text{C}$ , test of non-operated, No abnormality in electric and mechanical characteristic after 2 hours recovery at the room temperature.

(在  $-25\pm 2^{\circ}\text{C}$  非工作状态下进行试验, 试验后常温放置 2 小时后测试无异常)

 <b>深圳市汇科源电子科技有限公司</b> Shenzhenshi Huikeyuan Electronic Tech.co., LTD		<b>REVISION</b> (版本)	A0
		<b>DATE</b> (日期)	2023.06.08
<b>PART NUMBER</b> (产品编号)	<b>CAR CHARGER</b> <b>C140-140W USB C</b>	<b>CUSTOMER NAME AND MODEL</b> (客户名称和型号)	

#### 8.4 Storage at the Higher Temperature (高温放置)

At 70±2°C, test of non-operated, No abnormality in electric and mechanical characteristic after 2hours recovery at the room temperature.

(在 70±2°C 非工作状态下进行试验，试验后常温放置 2 小时后测试无异常)

#### 8.5 Storage at High Temperature and High Humidity (高温高湿度放置)

At 40±2°C,90~95%RH, test of operating 48hours,no abnormality in electric and mechanical characteristic, after 4hours recovery at the room temperature.

(在 40°C ±2°C,90~95%RH, 非工作状态试验持续 48H, 试验后常温放置 4 小时测试特性无异常)

#### 8.6 Storage at low Temperature and Low Humidity (低温低湿度放置)

At -10°C ±2°C,10%~40%RH, test of operating 48hours,no abnormality in electric and mechanical characteristic, after 4hours recovery at the room temperature.

(在-10°C ±2°C,10%~40%RH, 非工作状态试验持续 48H, 试验后常温放置 4 小时测试特性无异常)

### 9 Photograph of the Product (产品外观图)

#### 11.1 Enclosure/外壳:

The power supply size: 91.2x38x28mm; 外壳尺寸: 91.2x38x28mm;

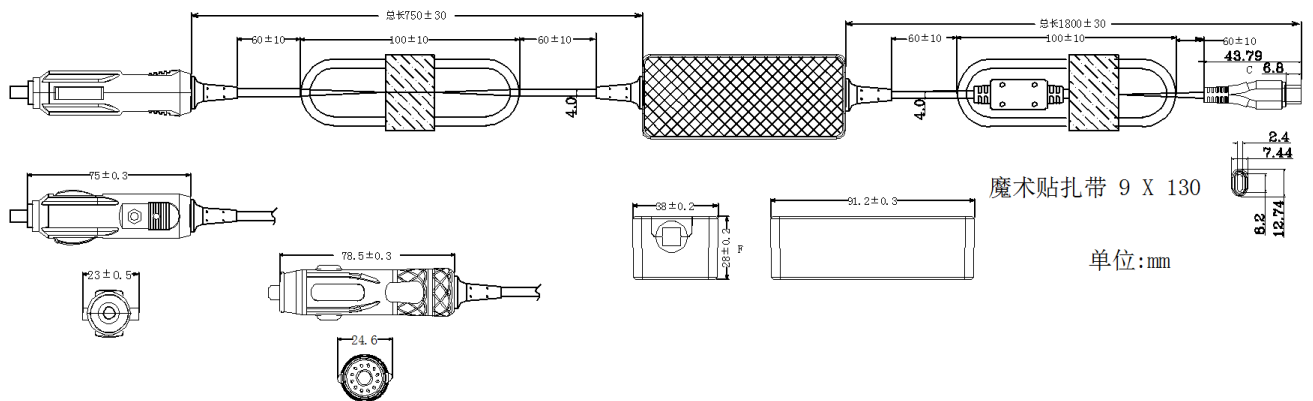







 <b>深圳市汇科源电子科技有限公司</b> Shenzhenshi Huikeyuan Electronic Tech.co., LTD		<b>REVISION</b> (版本)	A0
		<b>DATE</b> (日期)	2023.06.08
<b>PART NUMBER</b> (产品编号)	<b>CAR CHARGER</b> <b>C140-140W USB C</b>	<b>CUSTOMER NAME AND MODEL</b> (客户名称和型号)	

满天星壳子\_299号刀模\_C100专用刀模\_88.1x35mm





**140W KFZ Netzteil**  
**INPUT DC12V-24V(9V-32V Max)**







**DC Car Charger Travel Adapter**  
 DCカーチャージャー旅行アダプター  
**Power: 140W USB- C PD3.1**  
**Model(型号/型番): C140-140W USB C**  
**Input(输入/入力)DC:12V-24V 12A Max**  
**Output(输出/出力)DC: 5V≒3A,9V≒3A,12V≒3A,**  
**15V≒3A,20V≒5A,28V≒5A**











Shenzhen Huikeyuan Electronic Technology Co.,Ltd

MADE IN CHINA